















CARMIX 2.5 TT

-  **MIXING UNIT:** Drum Capacity 3.400 liters. Concrete output: 2,5 m3 per batch. Double mixing screws, cover for emergency unloading. Drum rotation by hydraulic motor and planetary reducers. Mixing and discharging speed independent from r.p.m. of diesel engine. Discharging by reversing drum. The mixing unit is slewing hydraulic through 300° for high discharge over 1,9 m on the four sides of the vehicle.
-  **ENGINE:** Diesel PERKINS 1104 D-44 TA Turbo, water-cooled, 4cylinders. Rated power KW 63 (84 HP) set at 2200 rpm. Engine mounted transversal on the rear.
-  **TRANSMISSION:** Hydrostatic. Bosch-Rexroth.Pump and motor are connected to the differentials through a 2 speed reducer (working and transfer). 4 wheel driving and steering.
-  **SPEED:** Working speed from 0 to 9 km/h, road transfer from 0 to 25 km/h. Electric servo control.
-  **DRIVING SEAT:** Front cab on side of loading shovel. ROPS-FOPS type complete with double closing door.
-  **CHASSIS:** Steel profile specially engineered for off-road operations.
-  **HYDRAULIC SYSTEM:** Three circuits. 2 variable outlet pumps for hydrostatic transmission and drum rotation. 2 gear pumps for services. Inlet and outlet filter. Heat exchanger water/oil-air-air type.
-  **JOYMIX:** All hydraulic functions of shovel controlled by a single fully servo controlled Joystick.
-  **LOADING SHOVEL:** Capacity 400 liters. Complete with hydraulic opening gate.
-  **CHUTE:** Slewing and hydraulically tilting. Fitted with two pins easily detachable to increase the discharge height.
-  **WATER SYSTEM:** Self-contained. Hydraulic driven water pump, water meter, washing outlet. High pressure water pump (on request).
-  **GRADIENT:** Fully loaded 30%.
-  **BRAKES:** Oil bath disc brakes inside differential axles. Twin independent circuits. Negative hydraulic parking brake.
-  **TYRES:** Off road industrial type 12,5-20 PR 12
-  **STEERING:** Hydrostatic on 4 wheels 4x4x4. Radius: internal mm. 1500, external mm. 3500
- **ELECTRIC SYSTEM:** 12 Volt. 120 Ah battery for electric starter and road lighting. Safety battery cut-off.
- **TANKS:** Water: 2x270 liters. Diesel: 105 liters. Hydraulic oil: 80 liters.
- **WEIGHT:** About Kg. 6000 Equally distributed on both axles.
- **SAFETY:** Carmix is equipped with checking and block valves for maximum safety of the operator. Self Control system avoids drum to slew if shovel's arm is lifted.
- **CATALOGUES:** Carmix is equipped with Use and Maintenance and Spare Parts Manuals according to CE regulations.

As result of our policy of continuously developing and improving our product range, all specifications may change without notice. graphic CARMIX - studio elbart 0421-460750

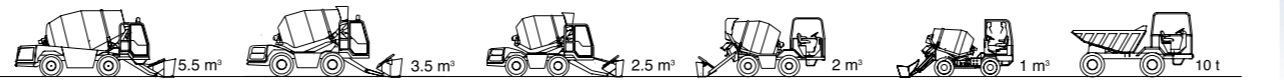
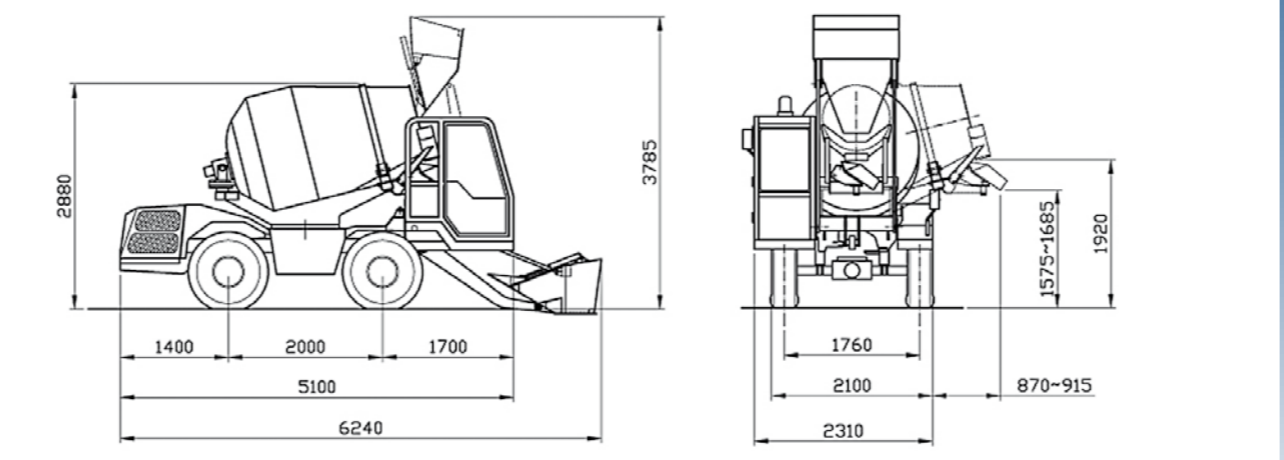

Metalgalante, the Company that invented and developed CARMIX, the No. 1 in the 4x4 Self-Loading Concrete Mixer. Thanks to 40 years of experience, CARMIX represents world-wide the Ideal Solution to produce high-quality cost-effective concrete wherever and whenever needed. From our Venice based factory, thousands of CARMIX have reached our Customers to over 130 Countries matching their utmost expectations.



30020 Noventa di Piave (Venice) Italy
 Tel.+39.042165191 - Fax +39.0421658838
 info@carmix.com
 Skype: carmix.main

METALGALANTE carmix.com

Carmix 2.5 TT Self Loading Mixer - Apollo Carmix



CARMIX 2.5 TT

EASY & ECONOMIC CONCRETE ANYWHERE



CARMIX 2.5 TT



THE 4X4 SELF-LOADING CONCRETE MIXERS AT THE MAXIMUM POWER.

- Choose CARMIX as your concrete “official supplier” in your site: thanks to the built-in technology and solution, CARMIX feeds itself, produces, transports and pours over 80 m3 of concrete per day.
- CARMIX greatly reduces production costs of concrete, avoids wastes (time too) and rationalizes the site producing just in time only what is required.
- Easy and intuitive electronic “LOAD CELLS” dosing system to guarantee a total quality of concrete produced, which make CARMIX ideal for any job site. (On request)
- The 360° series includes today CARMIX 3.5TT, and CARMIX 2.5TT: two different models, one sole philosophy to assure 360° quality concrete at low costs in any type of site ensuring an excellent comfort of the operator and therefore bigger production.
- 360° is the magic number of CARMIX revolution to allow the operator, with the simple fingers pressure, to discharge concrete around the 4 sides of CARMIX at over 2 meters height without any manoeuvre.

WHAT MAKES CARMIX THE N. 1

- Front driving cab to assure perfect visibility and excellent comfort to the operator.
- 360° discharging of concrete around the 4 sides at over 2 meters height.
- Self-Articulated hydraulically operating shovel for a more accurate loading of aggregates and materials.
- Rear engine: easy checks. Fully balanced equipment.
- Oil-bath built-in disc brakes: no maintenance at all and total reliability.
- Rich fully equipped cockpit. Ergonomic Joymix one joystick operates all main functions.
- Electronic weighing system with printer to certify 100% quality of concrete. (On request)
- CARMIX selects the best suppliers in order to assure its customers not only with top quality but also their worldwide after-sale network. Among others we are proud to name PERKINS engines, BOSCH-REXROTH transmissions, DANFOSS hydraulic motors, DANA SPICER axles,...

JUST SUPPLY THE MATERIAL AND LET CARMIX...

LOAD:

Thanks to its ultimate unique articulated hydraulically operating shovel, CARMIX easily manages all the loading operations of the aggregates with perfect accuracy. The blade fitted inside the shovel permits the breaking of cement bags with no waste. From the shovel any material will flow smoothly and quickly into the drum. (Electronic weighing system “load cells available on request).

MIX:

Once in the drum, aggregates and cement are perfectly mixed together with the self-pumped water from the twin tanks. Mixing quality and therefore concrete quality is granted by the double “T” type screw 4mm thick.

DELIVER:

No place is too difficult for CARMIX. The 4 wheel drive hydrostatic transmission along with the ideal weight balance allow CARMIX to climb fully loaded over 30% gradients.

DISCHARGE:

The CARMIX Revolution! With the drum slewing 300° the operator, pours concrete around the 4 sides of the vehicle at over 2m of height.

